



## FRONT AND REAR TOWING EYES

-  The towing eyes at the front and rear of the vehicle are designed for on-road recovery only. If they are used for any other purpose, it may result in vehicle damage and serious injury.
-  Remove the front and rear towing eye covers before driving off-road, to prevent damage or loss.

## OFF-ROAD RECOVERY

-  If the towing eyes are to be used for off-road recovery, it is essential that off-road driver training covering recovery techniques is undertaken. Further information on off-road driver training can be found at <http://www.landroverexperience.com>

## FRONT TOWING POINT

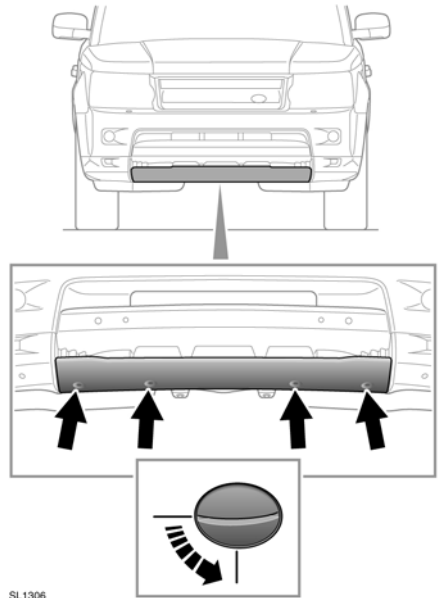

SL1306

The front towing point is located behind a removable cover in the lower front bumper.

1. Rotate each of the fasteners 90 degrees anticlockwise with a coin (or similar).
2. To remove the cover, lower the top edge and then pull the cover forward.
3. To refit, offer up the cover and ensure the two lugs at the bottom edge engage with the holes in the body panel.
4. Secure the cover in position by rotating each of the fasteners 90 degrees clockwise.

## REAR TOWING POINT

The rear towing point is located behind a removal panel in the lower rear bumper.

The rear towing point may be used to tow another vehicle if required.

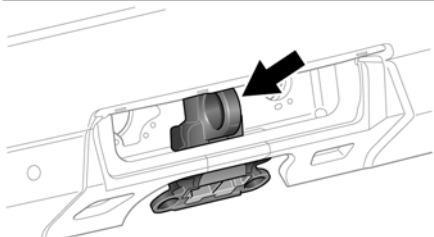
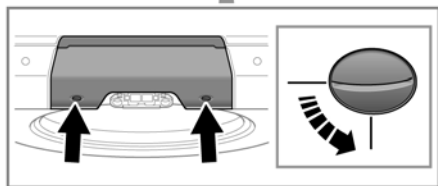
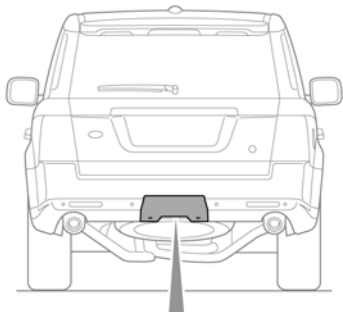

SL1308

1. Rotate each of the fasteners 90 degrees anticlockwise with a coin (or similar), to release the lower edge.
2. Rotate the cover to release the hooks at the top.
3. Remove the cover.

4. To refit, position the cover in place and ensure that the four hooks on the top edge engage in the body panel.
5. Rotate the fasteners 90 degrees clockwise to secure the cover.

## TOWING THE VEHICLE ON FOUR WHEELS



**Do not remove the Smart Key from the vehicle as this will lock the steering column.**



**If the vehicle battery is to be disconnected, the steering column must be unlocked first. It is not possible to unlock the steering column with the battery disconnected.**



**If the engine cannot be used during towing, there will be no power assistance to the braking or steering systems. This will result in much greater effort to steer and stop the vehicle and in a greatly increased stopping distance.**



Only tow the vehicle in a forward direction with all four wheels on the ground. Towing in a reverse direction with two wheels on the ground, will cause serious damage to the transmission.



The vehicle should only be towed for a maximum of 50 km (30 miles), at a maximum speed of 50 km/h (30 mph). Towing for a greater distance or at a higher speed, may result in serious damage to the transmission.



Do not tow the vehicle if the gearbox cannot be set in neutral, or the rear electronic differential has failed in the locked position.

Your vehicle has a permanent four-wheel drive system and is fitted with a steering lock. The following procedure must be carried out carefully to prevent damage to the vehicle:

1. Secure the towing attachment from the recovery vehicle to the front towing point.
2. With the parking brake applied, switch on the ignition.
3. Apply the foot brake and place the gear lever into neutral.
4. Switch off the ignition and leave the Smart Key in a secure place within the vehicle.
5. The ignition may be switched on to allow operation of indicators, brake lamps etc.
6. Release the parking brake before towing the vehicle.



Leaving the ignition switched on for extended periods will drain the vehicle battery.

## AFTER TOWING ON FOUR WHEELS

1. Apply the parking brake.
2. Switch on the ignition and apply the foot brake.
3. Place the auto selector lever in the park position.
4. Switch off the ignition and remove the Smart Key from the vehicle.
5. Remove the towing attachment and refit the cover to the front towing point.



**Use extreme caution when detaching towing equipment. Vehicle movement is possible which can result in serious injury.**